

Installation Instructions

Ground Fixed

HD Sonora
Page 1 of 3

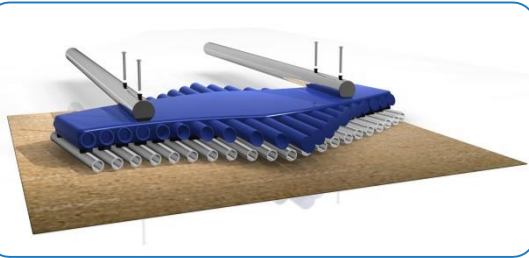

1. Carefully lay 2 x legs on a level surface and insert **M10x200 bar and nuts**. Using packing box as protection lay instrument note side down on the card. Line up pre drilled holes in the backboard with the legs and ensure the instrument is aligned square with the legs. **Fix** in place using **M8x30mm barrel nuts** supplied (see installation guide)

5. Beaters can be fixed to Stainless Steel posts with fixings provided

Install Instrument with 1.5m free space (from widest point) around it.

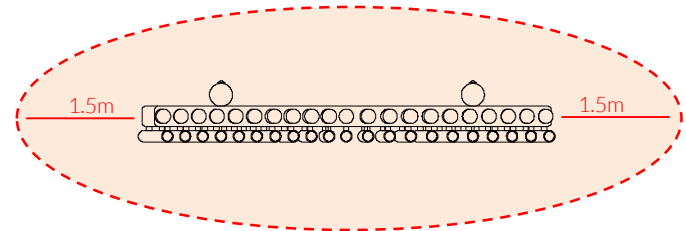

2.(See ground fix sheet)**Excavate 2 holes** on site of installation approximately Minimum **600mm deep** (adjust depth according to age range for intended players)

3. Carefully raise the instrument from the ground with legs attached and locate (lower) legs into holes making sure they are vertical and level prior to concreting in place.

4. Once happy with location and levels, **fill** holes using rapid hardening **concrete**. Be sure to compact concrete around legs and leave to dry according to manufactures guidelines

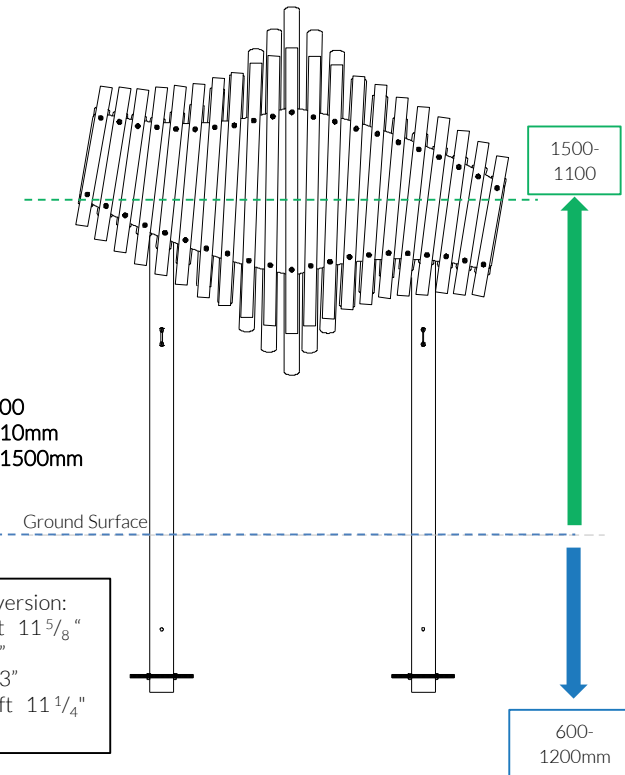

Metric Conversion:
600mm/ 1 ft 11 5/8"
900mm/ 35"
1100mm/ 43"
1200mm/ 3ft 11 1/4"
1.5m/ 59"

Components:

-  x4
- M8 Barrel Nut
-  x2
- Eye Straps
-  x4
- M6x20mm Secure Screw





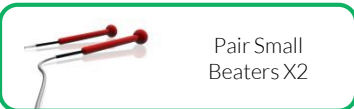

Weight of heaviest part 30kg

Thread Lock Solution Required (Not Supplied)





Ground Fix Components:

-  x4
-  x8
-  x2
-  x2

Spares available from percussionplay.com or from your local distributor

42 Kg

Tools:

 x1
  x1
 TX 45 Driver Bit TX 30 Driver Bit

Ground Fixed
HD Sonora
Page 2 of 3

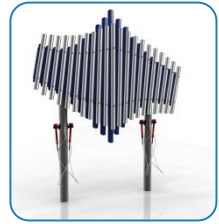





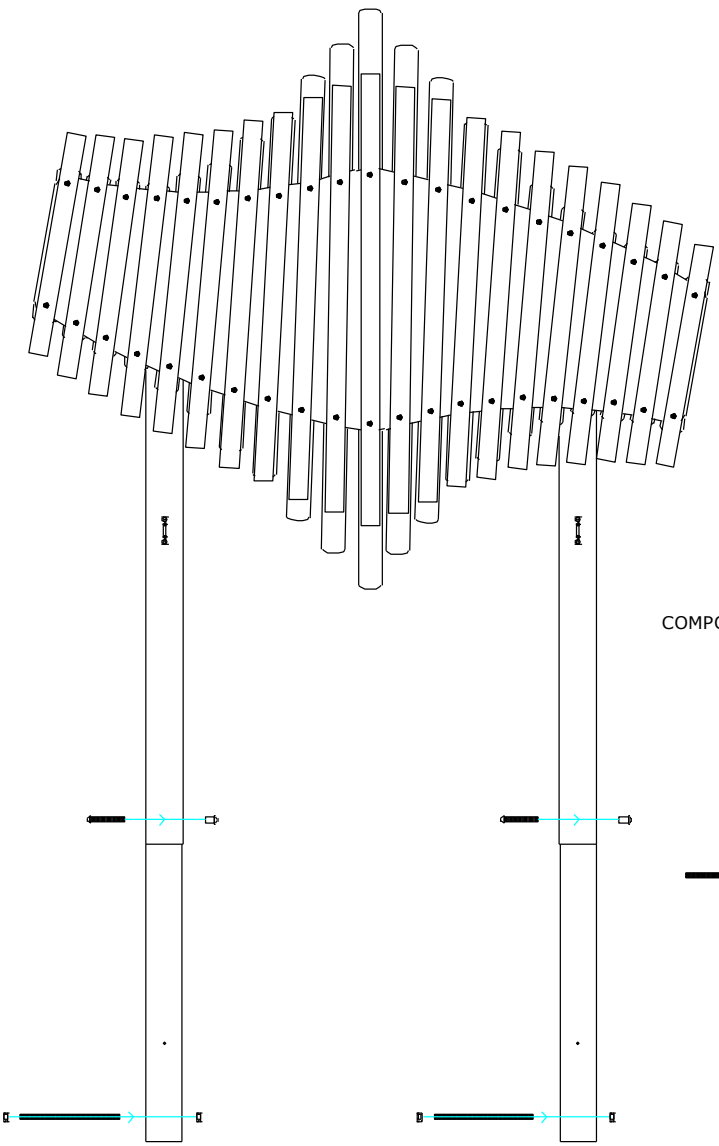
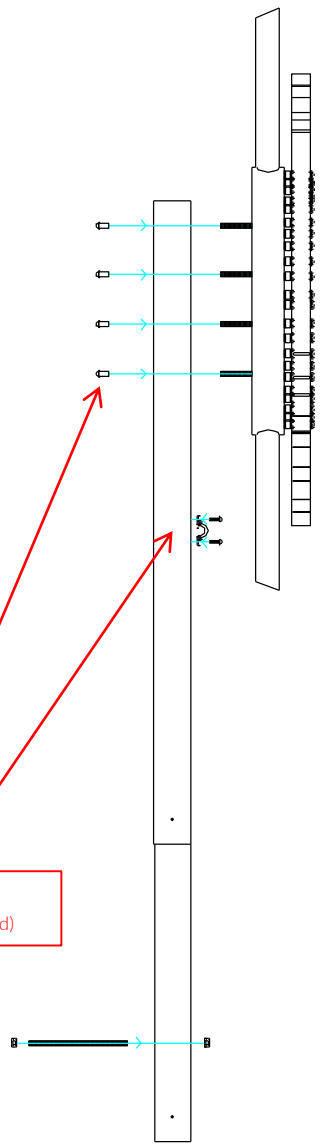

- Components:**
-  x4
 - M8 Barrel Nut
 -  x2
 - Eye Straps
 -  x4
 - M6x20mm Secure Screw

Thread Lock Solution
Required (Not Supplied)





Thread Lock Solution
Required (Not Supplied)



- COMPONENTS LIST:**
-  Saddle Strap X2
 -  M6x20 Pin torx X4
 -  M8 Barrel Nut Pin torx X4
 -  M10 Nut X8
 -  M10x200 Threaded Bar X4
 -  M10x70 Pin torx X2
 -  M10 Barrel Nut Pin torx X2

 Pair Small Beaters X2

Ground Fix Components:

-  x4
-  x8
-  x2
-  x2

Spares available from
percussionplay.com or from your
local distributor

37 Kg

Foundations should not present a hazard. These foundations are recommended as a guide, for more information on foundation details for various surface see Part 7 of BS EN 1176.

Ground Fixed

Sonora
Page 3 of 3

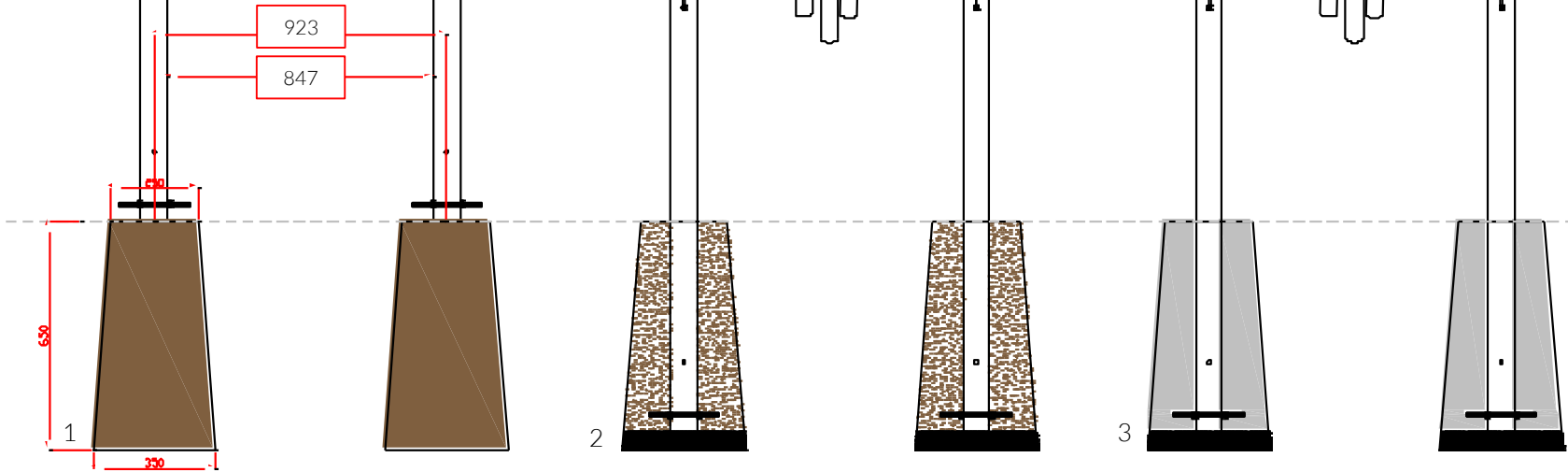
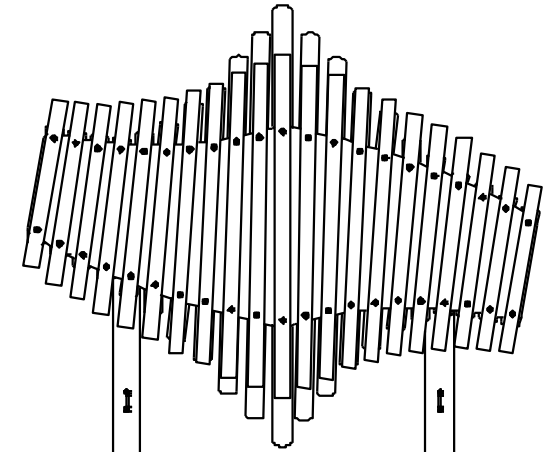
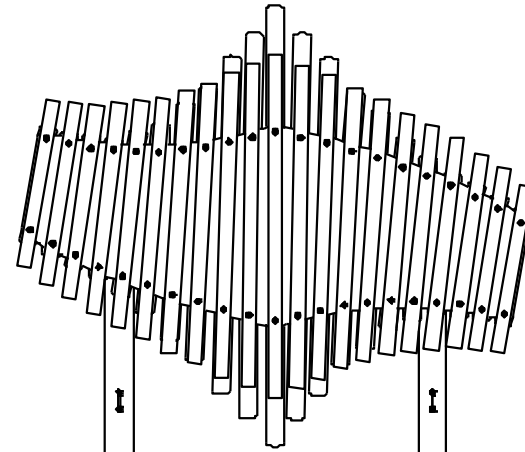
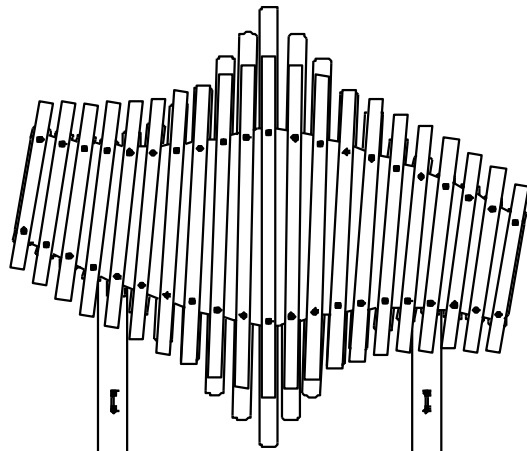
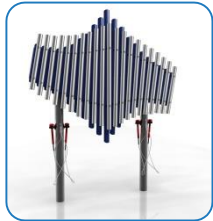

Excavate 2 holes with a 250mm diameter tapering down to 150mm diameter and 600mm depth
600mm min depth- Max Depth 1200mm

Compact base of hole with 50mm of aggregate. Lower ground Fix posts attached to instrument into hole (check instrument straight and level, and at correct height before filling with concrete)

Fill hole with fast drying concrete to manufacturers specifications. If posts protrude above instrument they can be cut down

Components:

M10x200mm
BZP Bar
X4

M10 BZP Nut
X8

Metric Conversion:
50mm/ 2"
250mm/ 10"
350mm/ 14"
650mm/ 2 ft 1 19/32"